



Order No. 4.40050 Stool with Back

Photo © Daniel Perales

Play value

Children love furniture which is provided especially for them. They prefer unusual seating which they can also use for play activities. The Round Table with 8 Benches encourages communication, and, at the same time, it can be the focal point of an outdoor area. A round table, even a small one, encourages common activities. It allows people to look at each other, thus making it easier to develop a community spirit.

Fundamental characteristics

- Wooden surface which appeals to the senses
- Agreeable design



Order No. 4.35000 Round Table with 8 Benches, Photo © Daniel Perales



Order No. 4.40051 Stool without Back, Photo © Daniel Perales

**Round Table with 8 Benches
Round Table
Stool with Back
Stool without Back**

Recommended for

- Kindergarten children
- Public play areas without supervision, such as playgrounds, parks or similar
- Swimming pools without supervision, such as outdoor pools, adventure pools or similar

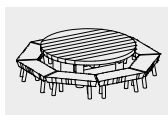

4.35000

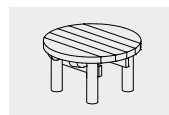

4.40000

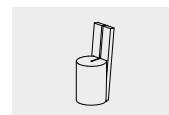

4.40050



4.40051

Order No. 4.35000
Round Table with 8 Benches

Safety distance 
 Device dimensions 
 Functional distance 

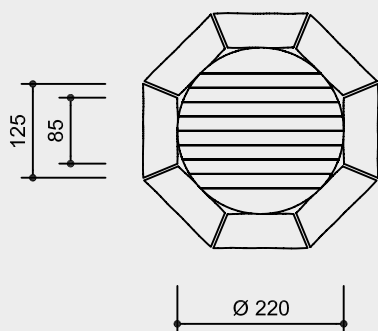

Order No. 4.40000 Round Table
Order No. 4.40050 Stool with Back
Order No. 4.40051 Stool without Back
 Example with 8 Stools

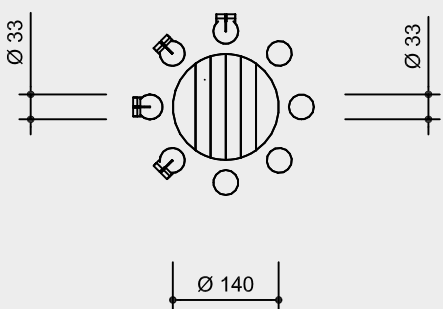
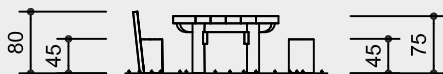

Scale 1:100

Safety check according to DIN EN 1176

Components

Order No. 4.35000

- 1 Round table top
- 1 Frame
- 8 Benches

Order No. 4.40000

- 1 Round table top
- 1 Frame

Order No. 4.40050

- 1 Stool with Back
- 2 Foundation irons, attached

Order No 4.40051

- 1 Stool without Back
- 2 Foundation irons, attached

Installation information

Surfacing requirements
 no requirements

Foundations
 only necessary to immobilise the equipment
 per foundation iron 20 x 20 x 30 cm
 Excavation depth 50 cm

Attention:
Exact measurements may vary;
for all installation dimensions refer
to current assembly instructions.
 Technical changes reserved.

Technical information

Equipment made of non-impregnated mountain larch

Peeled white

Palisades peeled white means that bark, cambium and sapwood are removed, the natural shape of the trunk is preserved and can be experienced



Core-free

Sawn-timbers core-free, thus decreasing occurrences of cracking and undesired changes in shape



Ground anchor

All parts used for anchoring to the ground are made of hot-dip galvanised steel or stainless steel



For more detailed explanation of the quality characteristics see price list.

Table tops of 10 cm thick boards, connected by additional hardwood tongue boards

Order No. 4.40050 Stool with Back
Order No. 4.40051 Stool without Back
 As above, but in addition with

Relief cut

Targeted relief cut as an effective measure against cracks caused by drying. The cut defines the position of the stress equalization in the trunk and minimises natural cracking



For more detailed explanation of the quality characteristics see price list.

Dimensions

(small deviations possible)

Order No. 4.35000
Round Table with 8 Benches

Table	
Diameter	2.20 m
Height	0.75 m
Weight	330 kg
Bench	
Length	1.25 m
Seat height	0.45 m
Weight	each 40 kg

Order No. 4.40000
Round Table

Diameter	1.40 m
Height	0.75 m
Weight	175 kg

Order No. 4.40050
Stool with Back

Diameter	0.33 m
Seat height	0.45 m
Weight	30 kg

Order No. 4.40051
Stool without Back

Diameter	0.33 m
Seat height	0.45 m
Weight	20 kg

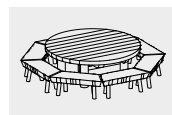

4.35000

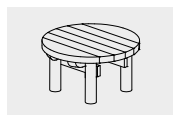

4.40000

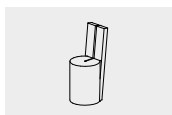

4.40050

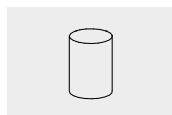

4.40051