

Play value

Our system of wooden water gutters consists of 10 elements of different shapes and functions which can be combined to individual water play installations. The gutters have different movable shutters, are installed with inclination or horizontal. They allow for interesting water play activities which are particularly attractive for children. The gutters - some of them are as wide as tables - can be used for playing with mud and distributing water. The feet have overlength, therefore it can be cut at different levels on the construction side. By this it is possible to take into account special requirements, e.g. of wheelchair bound children. This system of water gutters can be combined with different water wheels and Archimedes Screws.



Photo © Monica Bedmar



Photo © Anton Donikov



Photo © Anton Donikov



Order No. 5.10203 Channel with wedge seal
Photo © Anton Donikov

Water play elements made of wood

Fundamental characteristics

- Child proportions according to ergonomic requirements
- Use of natural wood which is appealing to the senses; the beautiful structure of the wood gets more and more visible by use
- Incentive for playing: wood, sand, water
- Movement: motor activities

Recommended for

- Kindergarten children
- Supervised play areas, such as kindergartens, schools, after-school programmes or similar
- Public play areas without supervision, such as playground, parks or similar
- Water play areas without supervision

Barrier-free

- Independent play



5.10103 - 5.15602

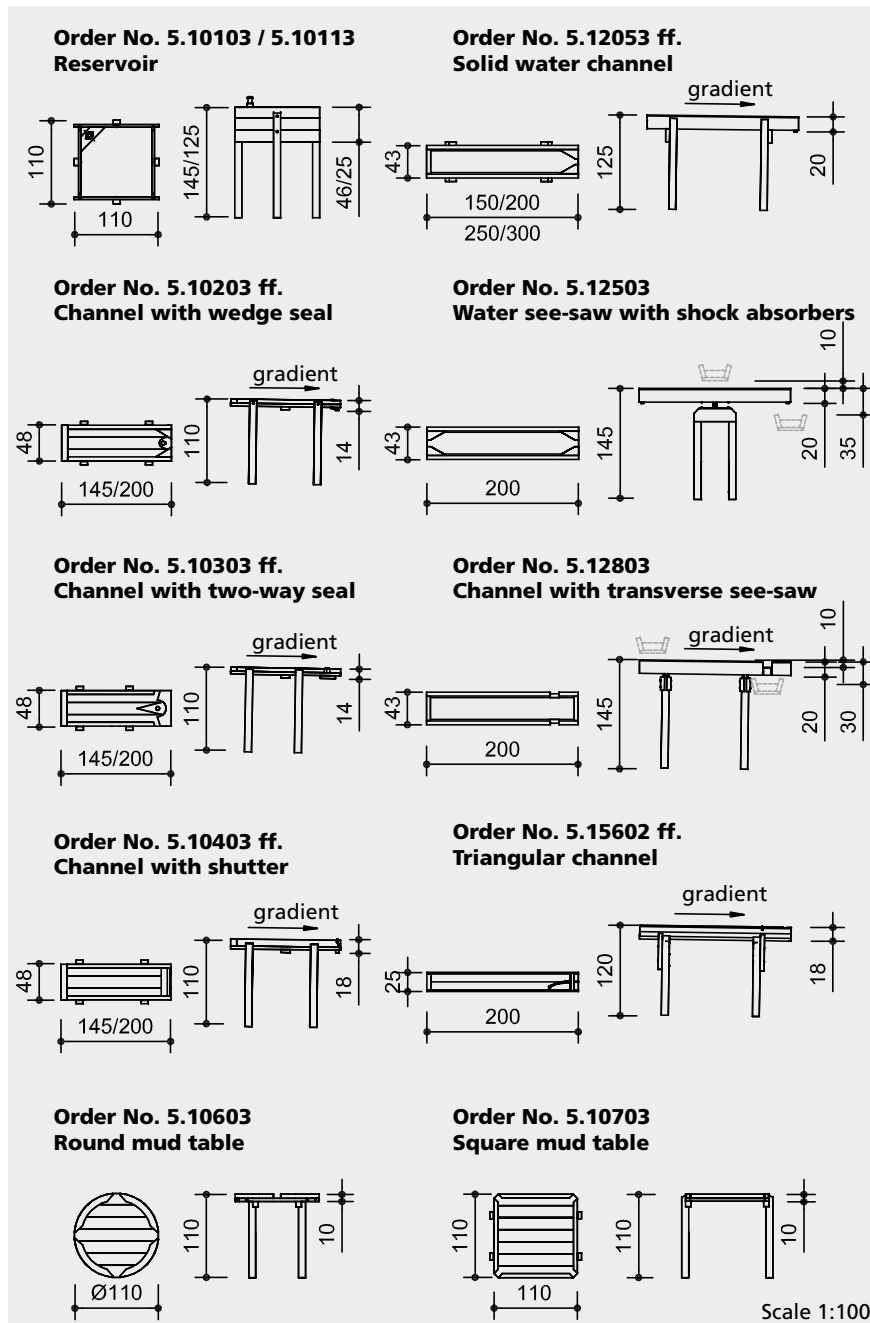

Safety check according to DIN EN 1176

Components

1 Element each,
with the corresponding number of
support posts each with steel feet



5.10103 - 5.15602

Installation information

Surfacing requirements
no fall height according to standard,
staircase-like constructions may make
necessary an examination of the fall
height

Recommendation: sand with drainage or
paving stone with gully; for playing with
„mud“, sand is required.

Required space according to overall
installation.
Foundations according to overall installa-
tion, excavation depth 70 cm each

Attention:
Exact measurements may vary;
for all installation dimensions refer
to current assembly instructions.
Technical changes reserved.

Technical information

Equipment made of non-impregnated
mountain larch

Core-free
Sawn-timbers core-free, thus decreasing
occurrences of cracking and undesired
changes in shape



Ground anchor
All parts used for anchoring to the
ground are made of hot-dip galvanised
steel or stainless steel



Order No. 5.10103 / 5.10113

Tongue and groove
Tongue and groove planks made of
4 cm solid wood, highly resilient, no
trickling of dust / sand, protection
against direct rain



Plywood
Plywood made of mountain larch,
three-layer (3 cm) or five-layer (4 cm).
High dimensional stability,
waterproof, glued according to
DIN EN 13353:2011



Sealed with microcellular rubber

Order No 5.10203 ff. / 5.10303 ff. / 5.10403 ff.

Tongue and groove
Tongue and groove planks made of
4 cm solid wood, highly resilient, no
trickling of dust / sand, protection
against direct rain



Sealed with microcellular rubber

For more detailed explanation of the quality characteristics see price list.

Order No 5.12053 ff. / 5.12503 / 5.12803

Floor made of planks 10 / 30 cm

Dimensions (See sketches)
(small deviations possible)

Weight 30 - 90 kg

Planning information

Equipment marked with a pointing arrow
needs to be installed with a gradient of
approx. 2% (= 2 cm on 1 m). This means
that for planning not only the height
of the equipment but also the gradient
needs to be taken into consideration.

The lengths of the support posts must
be checked for the planned installation
heights. The required lengths of the
support posts need to be calculated by
the customer taking into consideration
the installation depth (depending on the
surface) and the intended height (above
ground).

If several elements are installed in a line,
this might make necessary a correspon-
ding modelling of the ground.

Play value

Playing with mud, shaping and building with sand, earth and water is a fundamental human requirement, which even adults find difficult to suppress sometimes. With different types of water play equipment, children can gain insights into different functions and learn physical laws while playing. Troughs, water see-saws and mud tables ensure intense mud play which children often participate in together.



Order No. 5.15602 Triangular channel



Order No. 5.10603 Round mud table, Photo © Daniel Perales



Order No. 5.10603 Round mud table



Photo © Phil Wilkinson





Water play elements made of wood



5.10103 - 5.15602

Water play elements made of wood

Planning Example

Safety distance 
 Device dimensions 
 Functional distance 

Sectional drawing A

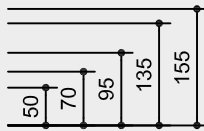
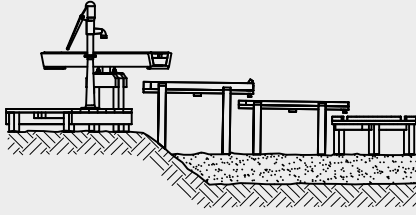
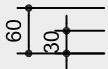

Sectional drawing B

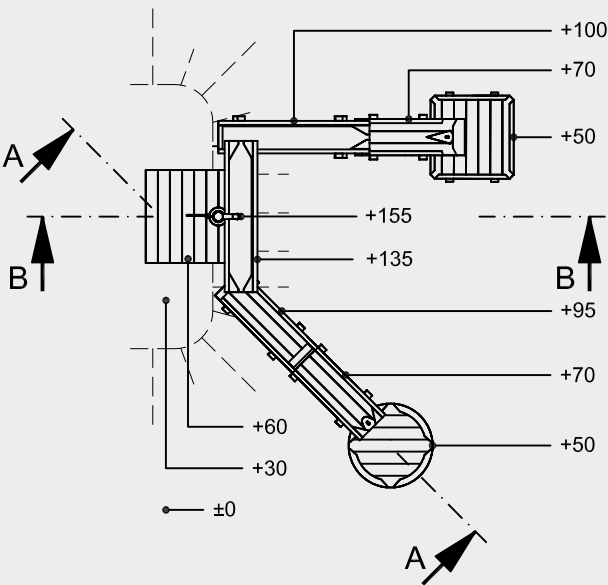
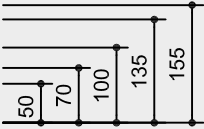
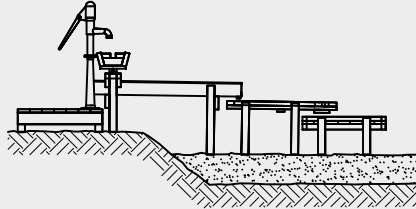
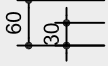

Scale 1:100

* The minimum height difference is the required distance between one element to the next. For see-saws the indicated measurements need to be kept to.

Order No. 5.10103 / 5.10113

Is usually allocated to pump, with bung for sealing;
 Height difference 50 cm * / 30 cm



Order No. 5.10203

Can be used as water play table;
 Height difference 17 cm *



Order No. 5.10303

Can be used as water play table and as distributor channel;
 Height difference 17 cm *



Order No. 5.10403

Can be used as water play table;
 Height difference 21 cm *



Order No. 5.10603

Is mostly used as final element of a water way,
 4 outlets;
 Height difference 18 cm *



Order No. 5.10703

Is mostly used as final element of a water way,
 4 outlets;
 Height difference 18 cm *



Order No. 5.12053

Basic element of this equipment group available up to 3 m length;
 Height difference 25 to 28 cm *



Order No. 5.12503

Two-way distributor with sturdy, buffered mechanism;
 Height difference 65 cm* to bottom, 15 cm * to top (see side view)



Order No. 5.12803

Transverse distributor on rubber buffers;
 Height difference 30 cm* to bottom, 10 cm * to top (see side view)



Order No. 5.15602

Standard length 2.00 m, but can also be delivered shorter;
 Height difference 24 cm *



5.10103 - 5.15602