

Play value

The element water, with its infinite forms of expression, is defined by its flow, vitality and power. It is only in ideal cases that a natural spring is located at a playground; however every play space needs water, even if it "only" comes out of a pipeline. A water pump with a swipe is especially attractive, where the act of pumping itself becomes a part of the play value, enabling access to the precious liquid. Even small children are able to pump water on the Crank Handle Pump with little effort. A gentle turn of the wheel is all it takes to get involved in the role-playing game with the element of water.

Fundamental characteristics

- Extremely sturdy playground pump
- Special design
- Incentive for playing: pump swipe (can be adjusted in 45° steps during assembly)
- Water is pumped on the Crank Handle Pump by turning the crank handle or rocking it back and forth
- Movement: physical effort



Photo © Monica Bedmar



Photo © Anton Donikov



Order No. 5.17630 Playground Pump, Photo © Paul Upward



Photo © Monica Bedmar



Order No. 5.17637 Crank Handle Pump

Recommended for

- Kindergarten children
- School children
- Water play areas without supervision

Planning information

These two types of pumps can deliver drinking water quality up to the underside of the piston.

Individual solutions for the water supply must be devised, depending on the plans. Up-to-date details on the connection for the water supply and other technical information is available to download as a table at our website

www.richter-spielgeraete.de

**Playground Pumps
Crank Handle Pumps**



5.17630 / 5.17640



5.17637 / 5.17638

Order No. 5.17630 / 5.17640
Playground Pump with integrated connection to mains water in the pillar
 Drinking water up to underside of piston

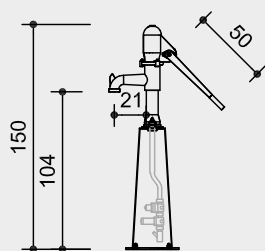

Order No. 5.17637 / 5.17638
Crank Handle Pump with integrated connection to mains water in the pillar
 Drinking water up to underside of piston

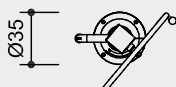
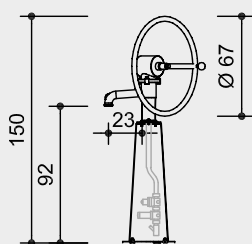

Safety distance →
 Device dimensions —●—
 Functional distance —|—

Scale 1:50

Safety check according to DIN EN 1176

Components

Order No. 5.17630 / 5.17640

- 1 Playground Pump with integrated connection to mains water in the pillar

Order No. 5.17637 / 5.17638

- 1 Crank Handle Pump with integrated connection to mains water in the pillar
Utility Model
 20 2020 100 441 Germany

Installation information

Surfacing must be ready to take heavy duty bolts.

Alternatively, the pumps can be mounted on the pedestals **Order No. 5.14190 / 5.19003** or foundation anchors **Order No. 5.17505 / 5.17633**.

Order No. 5.17630 / 5.17637

Pump must be drained during frost period; secure or remove handle/crank; we recommend disassembly.

Order No. 5.17640 / 5.17638

It is absolutely essential to disassemble the equipment during the period of frost.

Pumps for direct connection to mains water:

No underground shaft required for function.

Attention:

Exact measurements may vary; for all installation dimensions refer to current assembly instructions.
 Technical changes reserved.

For use in aggressive environments such as salt or chlorine water, the equipment is also available in marine grade steel (V4A).

Technical information

Order No. 5.17630 Playground Pump

Closed piston suction pump; all top parts made from hot-dip galvanised grey cast iron; cylinder housing, air dome cap, mounting plate, forked lever, plunging valve, gland flange and connecting rod are hot-dip galvanised; cylinder with a liner made of brass alloy and plastic piston (POM); drive shaft made of stainless steel, with replaceable brass bearing, additionally fixed with the gland flange using the shaft collar; secured against being extracted by means of a collar; drive shaft bearing made of brass with lubricating nipples; pump capacity: approx. 0.75 l per stroke, bore 75 mm, pump lift 170 mm the valve combination for direct connection to mains water, Ø 1 inch, and a shut-off valve with backflow preventer (type EA) and drainage are installed in the galvanised pillar made of steel; thread 1 inch; min. 2.5 bar water pressure, max. 6 bar, relief valve prevents swiipe from striking back, water requirement approx. 45 l/min

Order No. 5.17640

General pump specification as **Order No. 5.17630**; but in addition with programmable rinsing device, no connections to power supply required

Order No. 5.17637 Crank Handle Pump

Closed piston suction pump; pump and pillar made of stainless steel; cylinder and crank housing, mounting plate, piston rod and drive shaft made of stainless steel; the drive shaft brass bearing is replaceable, fitted with nipple for lubrication; cylinder with a liner made of brass alloy and plastic piston (POM); crank ring made of stainless steel, knob made of plastic material; the valve combination for direct connection to mains water, Ø 1 inch, and a shut-off valve with backflow preventer (type EA) and drainage are installed in the pillar made of stainless steel; external thread 1 inch; min 2.5 bar water pressure, max. 6 bar; relief valve prevents swiipe from striking back, water requirement approx. 18 l/min

Order No. 5.17638

General pump specification as **Order No. 5.17637**; but in addition with programmable rinsing device; no connection to power supply required

Dimensions

(small deviations possible)

Order No. 5.17630 / 5.17640

Playground Pump	
Equipment height	1.50 m
Width with horizontal pump swiipe	0.95 m
Weight	73 kg

Order No. 5.17637 / 5.17638

Crank Handle Pump	
Equipment height	1.50 m
Width	0.35 / 0.67 m
Weight	70 kg



5.17630 / 5.17640



5.17637 / 5.17638

Play value

The element water, with its infinite forms of expression, is defined by its flow, vitality and power. And if a playing observer interacts with it, various different sensory impressions are created.

It is only in ideal cases that a natural spring is located at a playground; however every play space needs water, even if it "only" comes out of a pipeline. A water pump with a swipe is especially attractive, where the act of pumping itself becomes a part of the play value, enabling access to the precious liquid. Our robust playground pumps therefore not only serve as a water supply, but also encourage work- and role-playing games and promote communication and cooperation.

Fundamental characteristics

- Sturdy construction
- Special design
- Incentive for playing: pump swipe (can be adjusted in 45° steps during assembly)
- Movement: physical effort



Photo © Monika Bedma

Order No. 5.17630 Playground Pump



Order No. 5.17500 Playground Pump

Playground Pumps

Recommended for

- Kindergarten children
- School children
- Water play areas without supervision

Planning information

Individual solutions for the water supply must be devised, depending on the plans. Up-to-date details on the connection for the water supply and other technical information is available to download as a table at our website www.richter-spielgeraete.de.

The water quality is to be clarified with the operator and the health authorities.

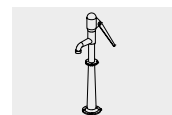

5.17500



5.17730

Order No. 5.17500
Playground Pump
 Self-priming

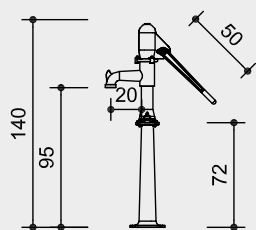

Order No. 5.17730
Playground Pump
 with water reservoir in the pillar
 Drinking water to underside of the pump base

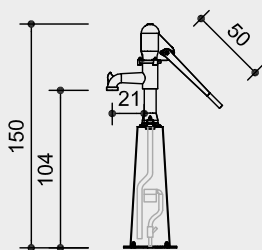

Safety distance →
 Device dimensions —●—
 Functional distance —|—

Scale 1:50

Safety check according to DIN EN 1176

Components

Order No. 5.17500
 1 Playground pump

Order No. 5.17730
 1 Playground pump
 with water reservoir in the pillar

Installation information

Surfacing must be ready to take heavy duty bolts.

Alternatively, the pumps can be mounted on the pedestals **Order No. 5.14190 / 5.19003** or foundation anchors **Order No. 5.17505 / 5.17633**.

Order No. 5.17500 / 5.17730
 Pump must be drained during frost period; secure or remove handle/crank. We recommend disassembly.

Pump Order No. 5.17730 for direct connection to mains water:

No underground shaft required for proper operation

Attention:
Exact measurements may vary;
for all installation dimensions refer to current assembly instructions.
 Technical changes reserved.

For use in aggressive environments such as salt or chlorine water, the equipment is also available in marine grade steel (V4A).

Technical information

Order No. 5.17500
Playground Pump

Closed piston suction pump; all parts made from hot-dip galvanised grey cast iron; cylinder housing, air dome cap, mounting plate, forked lever, plunging valve, gland flange and connecting rod are hot-dip galvanised; cylinder with a liner made of brass alloy and plastic piston (POM); drive shaft made of stainless steel, with replaceable brass bearing, additionally fixed with the gland flange using the shaft collar; secured against being extracted by means of a collar; drive shaft bearing made of brass with lubricating nipples; pump capacity: approx. 0.75 l per stroke, bore 75 mm, pump lift 170 mm, Inlet connection thread 1 1/4" external, suction resistant line 1 1/2", outlet connection thread 1 1/4" internal.

Order No. 5.17730

General pump specification as **Order No. 5.17500**; the water reservoir with float valve is integrated in the galvanised steel pillar; max. 6 bar water pressure; 1/2 inch external thread, pressure-resistant pipeline Ø 3/4 inch, water requirement approx. 15 l/min

Dimensions

(small deviations possible)

Order No. 5.17500
Playground Pump

Equipment height	1.40 m
Width with horizontal pump swipe	0.95 m
Weight	55 kg

Order No. 5.17730
Playground Pump

Equipment height	1.50 m
Width with horizontal pump swipe	0.95 m
Weight	73 kg



5.17500



5.17730

Play value

Our pump pedestals made of larch wood or stainless steel with a ribbed surface make it easier for smaller children to operate the crank or the swipe of our playground pumps.

Fundamental characteristics

- Sturdy construction
- Minimalist style
- Movement: climbing up

Recommended for

- Kindergarten children
- School children
- Water play areas without supervision



Order No. 5.19003 Pump Pedestal made of wood, Photo © Monica Bedmar



Order No. 5.14190 Pump Pedestal made of stainless steel

**Foundation Anchor
Winter Lid
Pump Pedestals**

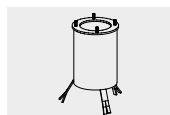

5.17505



5.17633

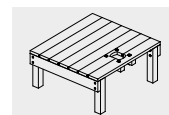

5.19003

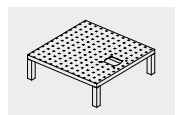

5.14190

**Order No. 5.19003
Pump Pedestal**

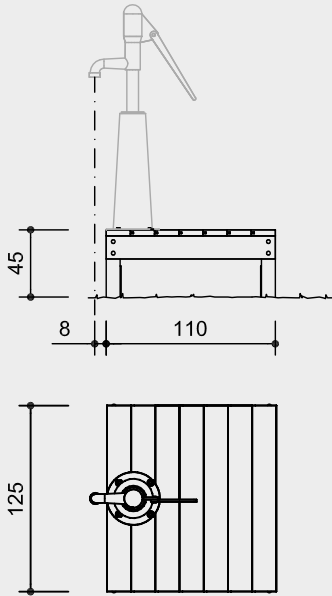

**Order No. 5.14190
Pump Pedestal made of stainless steel**

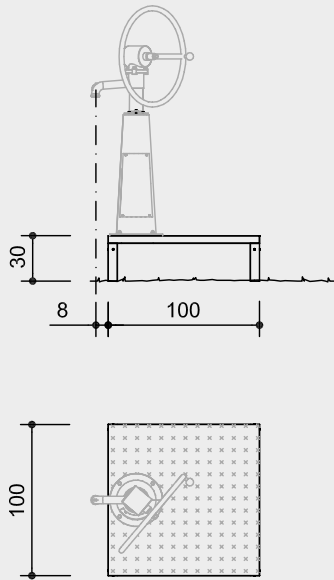

**Order No. 5.17505
Foundation Anchor**

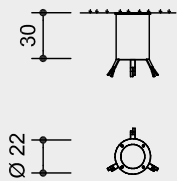

**Order No. 5.17633
Foundation Anchor**

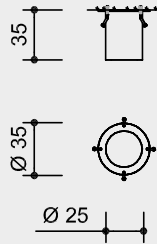

Safety distance →
Device dimensions —●—
Functional distance —|—

Scale 1:50

Safety check according to DIN EN 1176

Components

Order No. 5.17505

1 Foundation Anchor

Order No. 5.17633

1 Foundation Anchor for pumps

Order No. 5.17634 / 5.17635

1 Winter lid each

Order No. 5.19003

1 Pump pedestal with stand posts and steel feet

Order No. 5.14190

1 Pedestal with stand posts made of stainless steel for assembling

Installation information

Surfacing requirements recommendation: sand with drainage or pavement

Order No. 5.17505

Foundations 1 item 60 x 60 x 30 cm
Excavation depth 50 cm

Order No. 5.17633

Foundations 1 item 60 x 60 x 50 cm
Excavation depth 50 cm

Order No. 5.19003 / 5.14190
corresponding to a fall height of ≤ 0.60 m (please refer to price list for more detailed information)

Foundations 4 items 50 x 50 x 50 cm
Excavation depth 70 cm

The supply line underneath the pedestals is to be faced on site.

Technical information

Order No. 5.19003 Pump Pedestal
Equipment made of mountain larch

Core-free

Sawn-timbers core-free, thus decreasing occurrences of cracking and undesired changes in shape



Ground anchor

All parts used for anchoring to the ground are made of hot-dip galvanised steel or stainless steel



For more detailed explanation of the quality characteristics see price list.

Order No. 5.14190 Pump Pedestal

Equipment made of stainless steel, glass-bead blasted, surface made of embossed sheet metal, support posts 60 / 60 cm for assembling

For use in aggressive environments such as salt or chlorine water, the equipment is also available in marine grade steel (V4A).

Order No. 5.17505 Foundation Anchor

made of galvanised steel for
Playground Pump **Order No. 5.17500**

Order No. 5.17635 Winter Lid

made of stainless steel for
Playground Pump **Order No. 5.17500**
and Foundation Anchor
Order No. 5.17505

Order No. 5.17633 Foundation Anchor

made of galvanised steel for
Playground Pump **Order No. 5.17630 / 5.17730**

Order No. 5.17634 Winter Lid

made of stainless steel for
Playground Pump **Order No. 5.17630 / 5.17730** and
Foundation Anchor **Order No. 5.17633**

Dimensions

(small deviations possible)

Order No. 5.17505 / 5.17633

Height 0.30 / 0.35 m
Diameter 0.22 / 0.35 m
Weight 7.5 kg

Order No. 5.17634

Diameter 0.34 m
Thickness 2.5 mm
Weight 2 kg

Order No. 5.17635

Diameter 0.22 m
Thickness 2.5 mm
Weight 1 kg

Order No. 5.19003

Width 1.25 m
Depth 1.10 m
Max. height 0.45 m
Weight 95 kg

Order No. 5.14190

Width 1.00 m
Depth 1.00 m
Max. height 0.30 m
Weight 65 kg

Attention:

Exact measurements may vary; for all installation dimensions refer to current assembly instructions.

Technical changes reserved.

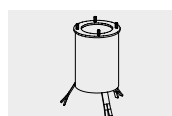

5.17505

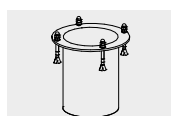

5.17633

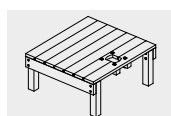

5.19003

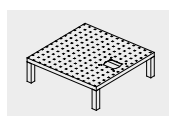

5.14190