



Photo © Paul Upward

Play value

Beam See-saws are available in different designs. The basic version has hand grips for two children, the beam is supported on a coloured metal axle. The Double See-saw has two grips on each side of the beam and can be used by four children at the same time. The Twin See-saw offers special fun as the see-saws are connected. Going up and down side by side is great fun.

Fundamental characteristics

- Progressive rubber buffers support the whole See-saw movement
- See-sawing is also possible alone
- Incentive for playing: coloured metal construction, grips
- Movement: see-sawing, pushing oneself off, shifting one's weight



Photo © Paul Upward



Order No. 6.11620 Twin See-saw, Photo © Barbara Evripidou



Order No. 6.11610 Double See-saw, Photo © Barbara Evripidou

Recommended for

- Kindergarten children
- School children
- Supervised play areas, such as kindergartens, schools, after-school programmes or similar
- Public play areas without supervision, such as playgrounds, parks or similar

Barrier-free

- Special exercise experience

**Beam See-saw
Double See-saw
Twin See-saw**

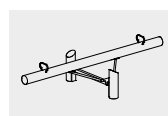

6.11600

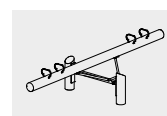

6.11610

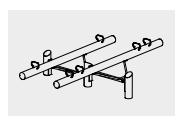

6.11620

Order No. 6.11600
Beam See-saw

Safety distance 
Device dimensions 
Functional distance 

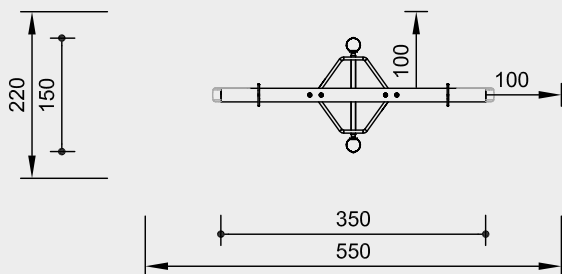
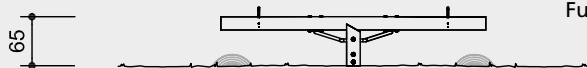

Order No. 6.11610
Double See-saw

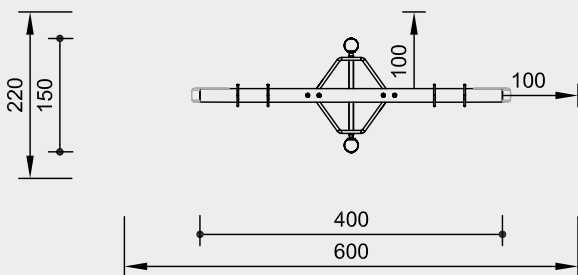
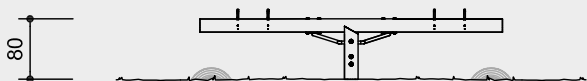

Order No. 6.11620
Twin See-saw

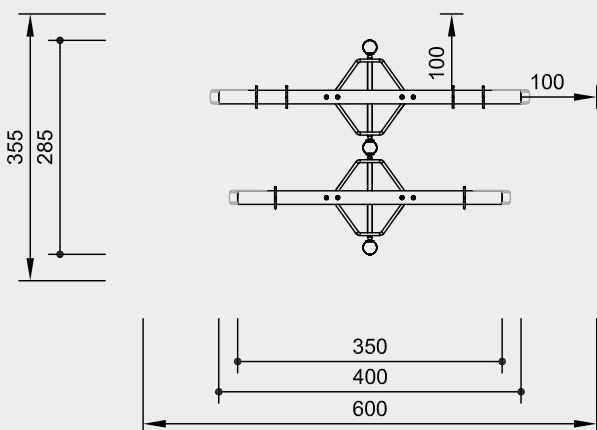
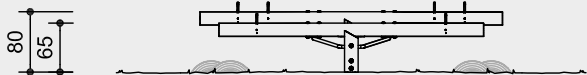

Scale 1:100

Safety check according to DIN EN 1176

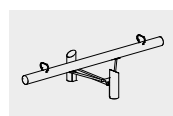

6.11600

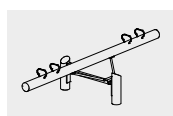

6.11610

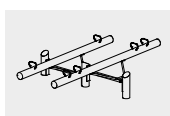

6.11620

Technical information

See-saw beam de-barked, made of non-impregnated mountain larch

Peeled white

Palisades peeled white means that bark, cambium and sapwood are removed, the natural shape of the trunk is preserved and can be experienced



Relief cut

Targeted relief cut as an effective measure against cracks caused by drying. The cut defines the position of the stress equalization in the trunk and minimises natural cracking



For more detailed explanation of the quality characteristics see price list.

Support posts made of robinia, Ø 15 - 18 cm

See-saw mechanism with rubber buffers, lacquered, standard colour blue
Grips made of stainless steel, glass bead blasted

Dimensions

(small deviations possible)

Order No. 6.11600 Beam See-saw

Max. See-saw height	1.35 m
Length	3.50 m
Width	1.50 m
Weight	120 kg

Order No. 6.11610 Double See-saw

Max. See-saw height	1.35 m
Length	4.00 m
Width	1.50 m
Weight	140 kg

Order No. 6.11620 Twin See-saw

Max. See-saw height	1.35 m
Length	3.50 / 4.00 m
Width	2.85 m
Weight	290 kg

Components

- 1 or 2 See-saw beams with grips
- 1 or 2 See-saw mechanism(en)
- 2 or 3 Support posts

Tyres as additional shock absorbers on site.

Installation information

Surfacing requirements corresponding to a fall height of ≤ 1.50 m (please refer to price list for more detailed information)

Foundations

Order No. 6.11600
2 items 60 x 60 x 60 cm
Excavation depth 80 cm

Order No. 6.11610
2 items 60 x 60 x 60 cm
Excavation depth 80 cm

Order No. 6.11620
3 items 60 x 60 x 60 cm
Excavation depth 80 cm

Attention:

Exact measurements may vary; for all installation dimensions refer to current assembly instructions.
Technical changes reserved.