

Play value

Climbing Structures made from hand-processed irregular round logs, can be integrated into a strongly nature-oriented environment due to their formal expressive character. Many children can play within a small space; Climbing Structures can even absorb the arrival of a large number of children who wish to play on it and incorporate all of them within a flowing play rhythm. Climbing Structures do not only allow for climbing, experiencing height, and for having a sensual experience with hands and feet, but they can also be used as a nice seat for relaxing and observing.



Photo © Marta Bellot



© Richter Spielgeräte GmbH 07/23

Climbing Structure 08

Fundamental characteristics

- Natural, strong posts
- No pre-determined play procedures, also able to be used in stages, individual mastering
- Incentive for playing: strong, challenging construction
- Movement: climbing, balancing, doing exercise

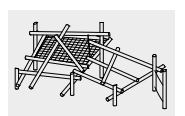

Recommended for

- School children
- Young people
- Supervised play areas, such as kindergartens, schools, after-school programmes or similar
- Public play areas without supervision, such as playgrounds, parks or similar



6.51008 / L6.51008

Order No. 6.51008 / L6.51008
Climbing Structure 08

Safety distance 
 Device dimensions 
 Functional distance 

Height details in meters

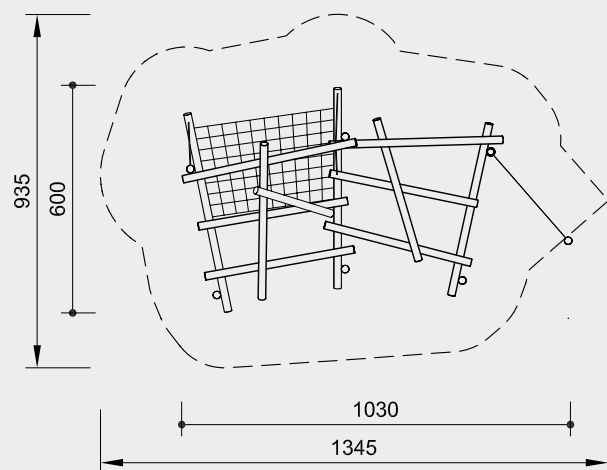
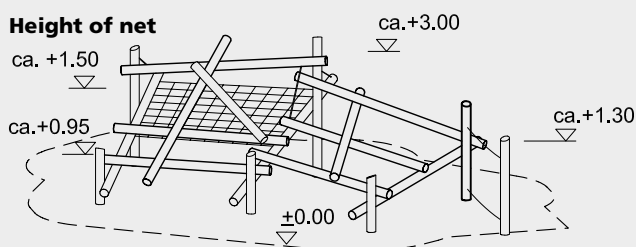

Scale 1:200

Safety check according to DIN EN 1176 and "safety in another way"

Components

- 7 Stand posts
- 12 Connecting tie beams
- 1 Net area
- 1 Balancing rope / holding rope
- Ropes for tensioning
- Fittings

Dimensions

(small deviations possible)

Length	10.30 m
Width	6.00 m

Installation information

Surfacing requirements corresponding to a fall height of ≤ 3.00 m (please refer to price list for more detailed information)

Foundations
 7 items 80 x 80 x 60 cm
 Excavation depth 80 cm

Note

The climbing structure is an individual construction which is only partly pre-assembled in our workshop. Therefore, the installation needs to be carried out by an installation company authorised by us.
 Technical changes reserved.
Equipment also available for environmental friendly foundations (Order No. G6.51008).

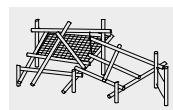

6.51008 / L6.51008

Technical information

Posts made of robinia, \varnothing 15 - 21 cm

Peeled white

Palisades peeled white means that bark, cambium and sapwood are removed, the natural shape of the trunk is preserved and can be experienced



Bevel cut

Vertical stand posts with bevelled end grain section as constructive wood preservation measure



Richter Hercules type rope

Richter Hercules type rope, a combination of galvanised six-strand steel cables and polyester yarn, diameter > 20 mm, laid and glued with very good abrasion resistance, strong sheathing even in the case of damage by puncturing



Aluminium rope pressing

Aluminium rope pressing, cylindrically pressed, with rounded ends



S-connectors

S-connectors \varnothing 8.1 mm, made of high-quality stainless steel, rounded



Profiled washer

Profiled washer for covering protruding screw heads according to standard, improved pressure distribution and protection against water. Impedes loosening the bolt



Adjustable

Adjustable two-piece bolt connection, easy to maintain, no projecting threads



Stainless Chains

Chains made of steel with high corrosion resistance. Short-linked, without eyelets on the connecting parts, easily replaceable and simple shortening



Distance fitting

Screw connection with distance fitting to avoid entrapment areas



Fastening of rope

Fastening of rope / net by means of adjustable chain fixation, easy assembly and maintenance



Standard colour rope: natural

Order No. L6.51008

As above, but de-barked posts made of non-impregnated mountain larch with steel feet, \varnothing 15 - 21 cm, splinter free

Ground anchor

All parts used for anchoring to the ground are made of hot-dip galvanised steel or stainless steel



Relief cut

Targeted relief cut as an effective measure against cracks caused by drying. The cut defines the position of the stress equalization in the trunk and minimises natural cracking



For more detailed explanation of the quality characteristics see price list.