

Instructions for wear checks of play equipment

The equipment must be checked for correct operation and safety, especially the points listed below:

Proof of maintenance

Playground

Date of installation

Checks depend on the type of equipment. Any equipment with moving parts must be checked at least twice a year, static equipment at least once a year.

Intervals for maintenance work and checks generally depend on

- location
- kind of use
- frequency of use
- possible vandalism

For more details see also "General instructions for maintenance of playgrounds".

High Swing special
as attachment to towers
Order No. 3.19032

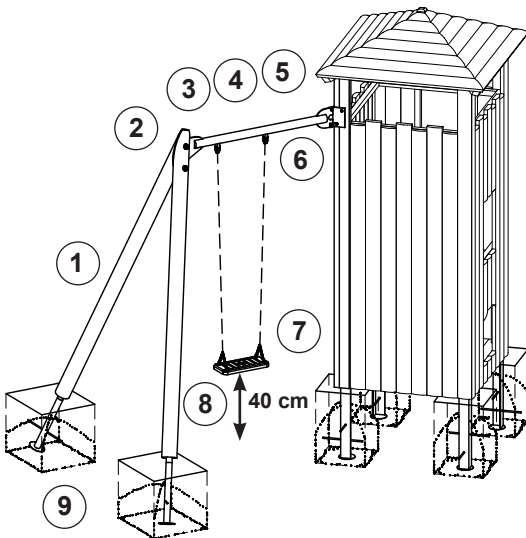

Wooden parts

1. Check for rot and, if necessary, smooth out splinters and round off sharp edges of cracks.
2. Check that all bolts and screws are tight and retighten if necessary.

Swing suspension

3. Make sure that the joints move smoothly.
4. Make sure that the swivels move smoothly, apply grease if required.
5. Check welds of metal cross beam for cracks.
6. Check chain and connection to chain; the first chain link must be locked firmly in the swivel; check wear on contact surfaces between first and second chain link.

Swing seat

7. Replace if metal parts are exposed.
8. Check the seat for a ground clearance of 40 cm.

Structural stability

9. In order to check the steel feet for corrosion, uncover the foundation once a year.

Special notes, e.g. for repairs

Repair not carried out, it is still possible to play on equipment

Repair not carried out, equipment is taken out of action

All work carried out, everything is in order

Maintenance carried out by:





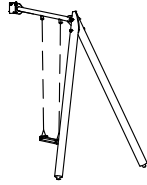

For spare parts refer to back of page.

..... Date

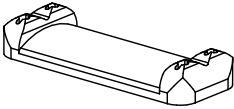
**Spare Parts
High Swing
special
Order No. 3.19032**

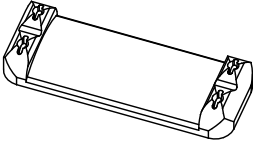

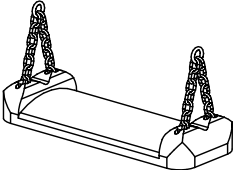
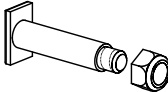
Please note that the safety standards of the equipment must not be affected. Therefore, when carrying out repairs it is helpful to **only use original parts**.

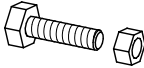
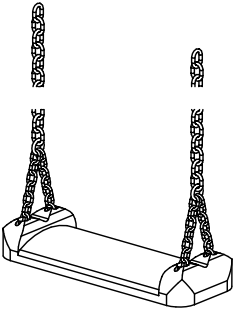
Order No. Spare part	Order No. Spare part
<p>0.93000 rubber swing seat</p> 	<p>0.93090 U-shackle with swivel</p> 
<p>0.93010 rubber swing seat with 4 eyebolts</p> 	<p>0.88150 brass bush for swing joint</p> 
<p>0.93020 rubber swing seat with 2 V-chains</p> 	<p>0.20010 stainless steel machine bolt M8x55 with locking nut</p> 
<p>0.93021 V-chain</p> 	<p>0.20020 stainless steel machine bolt M8x28 with locking nut</p> 
<p>0.93120 rubber swing seat with chains</p> 	
<p>0.93100 chains (pair) 6 mm length 2.35 m</p> 