

Instructions for wear checks of play equipment

The equipment must be checked for correct operation and safety, especially the points listed below:

Proof of maintenance

Playground.....

Date of installation

Checks depend on the type of equipment. Any equipment with moving parts must be checked at least twice a year, static equipment at least once a year.

Intervals for maintenance work and checks generally depend on

- the location
- the usage
- the frequency of use
- possible vandalism

For more details see also "General instructions for maintenance of playgrounds".

Street Acrobats Type 01
Order No. 4.16100

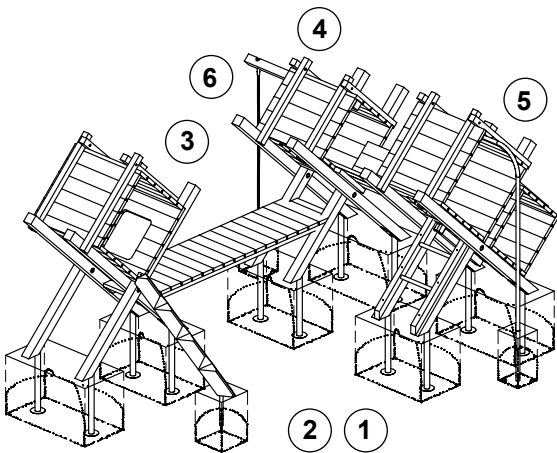

Structural stability

1. Uncover the foundations once a year in order to check the structural stability as follows:
 - wood for rot
 - steel for corrosion
 - anchoring to the ground for stability
 - condition of concrete foundations
2. Check that all bolts and screws as well as all wood joints are tight, retighten if necessary.

Wooden parts

3. Check for rot and, if necessary, smooth out splinters and round off sharp edges and cracks.
4. Recommendation: apply paraffin wax to the end grain areas once a year, especially near the ground; please refer to Order No. 0.90100, 1 litre.

Firemen's pole

5. Check that bolts and screws are tight and retighten if necessary.

Climbing rope

6. Check for wear and tear, if the steel reinforcement is damaged, it is imperative it be replaced.

Special notes, e.g. for repairs

Repair not carried out, it is still possible to play on equipment

Repair not carried out, equipment is taken out of action

All work carried out, everything is in order

Maintenance carried out by:

..... Date